



Grivory HT

**Enhanced Performance
at High Temperatures**

GRIVORY®
EMS



■ Contents

	Grivory HT
2/3	Introduction
3	Nomenclature/Product overview
	Highlights
	Grivory HT1VA
4/5	High Hydrolysis Resistance/Core Products
	Grivory HT6
6/7	Enhanced High Temperature/Core Products
9	Basic Product Assortment
10	EMS-GRIVORY Service and Support

■ Introduction

Grivory is the trade name for EMS-GRIVORY's family of semi-crystalline, partially aromatic polyamides. Grivory HT comprises of aromatic, semi-crystalline, high-performance products based on polyphthalamide (PPA) structure. Properties include:

- Excellent stiffness and strength at high operating temperatures
- Good resistance to chemicals and hot water
- Low absorption of moisture or water
- Low moisture effects on mechanical-physical properties
- Good dimensional stability and low warpage
- Good surface quality
- Economical manufacturing

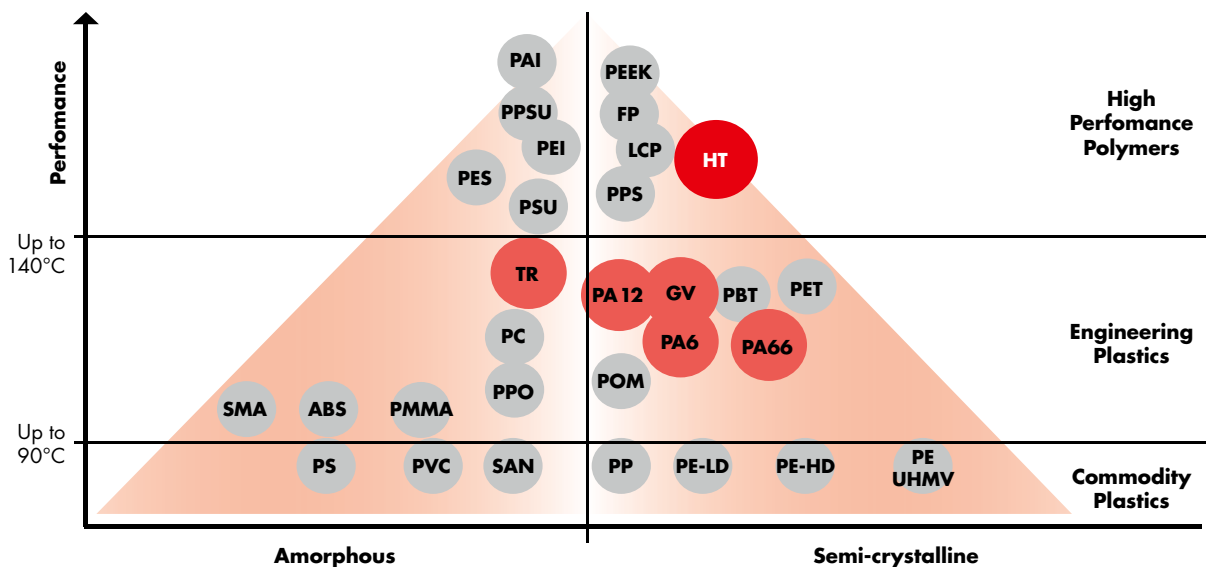

Grivory HT

Grivor HT includes several families groups with different base polymers:

Grivory HT1: PA6T/6I **Grivory HT3: PA10T/X**

Grivory HT2: PA6T/66 **Grivory HT6: PA6T/8T/X**

EMS-GRIVORY has designed the Grivory HT families with a high performance profile. The main distinguishing feature of Grivory HT compared to other polyamides is its good performance at high temperatures. This makes it possible to produce injection moulded parts economically with excellent mechanical properties, heat resistance and chemical resistance.

Grivory HT is an ideal construction material as a metal replacement and offers excellent opportunities for cost, and weight reduction and energy savings.

Grivory HT outperforms polyphenylene sulphide (PPS) and polyetheretherketone (PEEK) in terms of stiffness and strength at application temperatures up to 140°C.

HT Property comparison
[Scale of 1 to 10, where 10 is the highest]

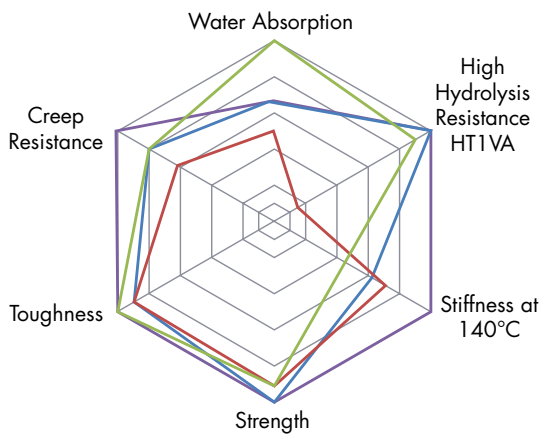

- HT1 [PA6T/6I]
- HT2 [PA6T/66]
- HT3 [PA10T/X]
- HT6 [PA6T/8T/X]

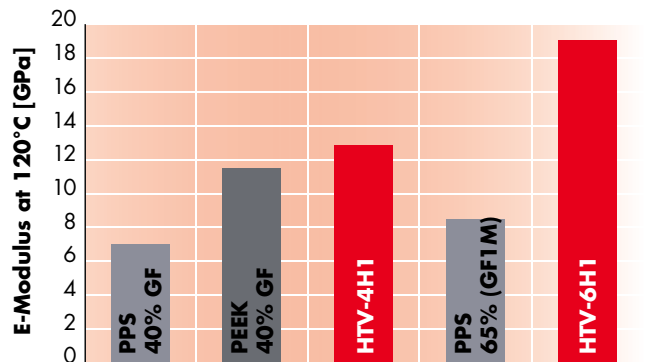

Nomenclature Grivory HT

1. Base Polymer

- 1: PA6T/PAI
- 2: PA6T/66
- 3: PA10T/X
- 6: PA6/8T/X

3. Modification

- A: Aqua (2nd Gen. HY/FWA)
- S: Improved surface
- Z: Impact modified

5. Head stabilisation

- H: Standard
- X: Electro compatible

Grivory HT	2	V	S	-	3	H	Blank	Colour xxxx
-------------------	----------	----------	----------	----------	----------	----------	--------------	------------------------

- ### 2. Reinforcement
- C: Carbon fibre
 - M: Mineral
 - V: Glass fibre
 - VL: Long glass fibre

- ### 4. Reinforcement
- 1/10 weight %

- ### 5. Additional
- FWA: drinking water / food approved
 - HY: Improved Hydrolysis
 - HYS: Hydrolysis & Demolding improved
 - LF: Low friction
 - LW: Laser-writable
 - VO: Flame retardant



■ Product overview

Property	Grade	HT1	HT2	HT3	HT6
High Hydrolysis resistance	HT1A-HY	X			X
High Hydrolysis resistance/suitable for contact with food and drinking water	HT1A-FWA	X			
Electro compatible stabilization	X	X	X	X	X
Flame retardant, halogen free (UL 94, VO)	VO		X	X	X
Long glass fiber reinforced	VL	X			
Carbon-fiber reinforced	C		X	X	X
Low friction	LF		X		X
Renewable raw materials				X	

■ Highlights

■ Grivory HT1VA High Hydrolysis Resistance

Grivory HT1VA is the new generation of optimized high hydrolysis resistant products. Products offer outstanding fatigue resistance of weld line strength, exceptional long term behavior and excellent hydrostatic strength. Improved demolding increases design freedom by opening the possibility for complex geometries. Processing is similar to Grivory HT1 where the melting temperature is 320°C to 340°C and tool temperature starts at 130°C. The product assortment comprises grades with electro-compatible stabilization and approvals for use in direct contact with food / drinking water.

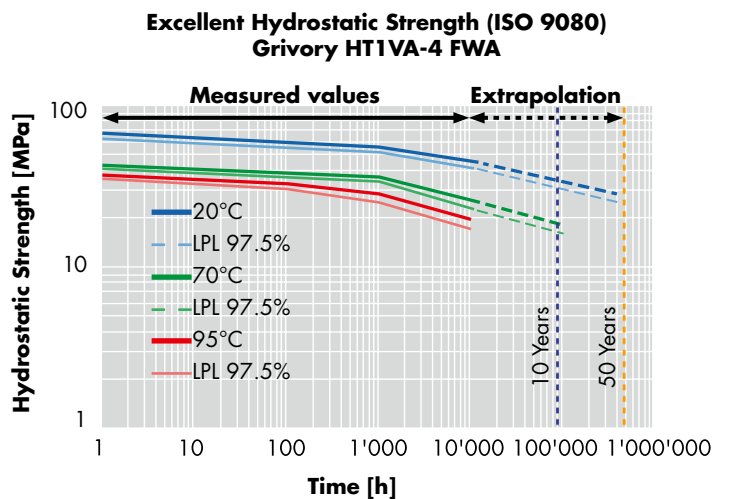
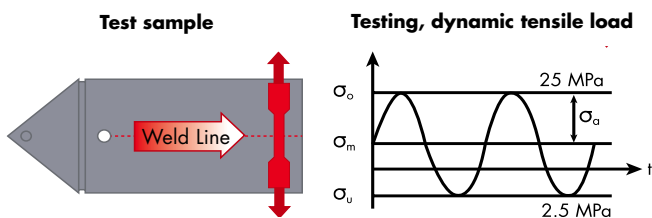
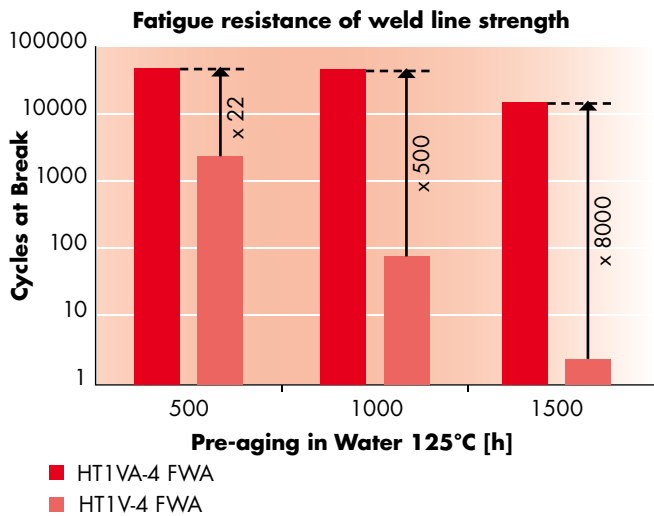

■ Grivory HT1VA Core products

Property	Standard	Unit	HT1VA-35 HYS	HT1VA-4 HY	HT1VA-4 FWA	HT XE 10814 ¹	HT1VA-5 HY	HT1VA-5 FWA
Degree of reinforcement	ISO 3451	%	35	40	40	40	50	50
E-Modulus	ISO 527	GPa	13.5/13.5	14.5/14.5	14.5/14.5	14.5/14.5	18.0/18.0	18.0/18.0
Tensile Strength at Break	ISO 527	MPa	230/220	250/230	250/230	250/230	275/260	275/260
Charpy Impact +23°C	ISO 179	kJ/m ²	50/50	70/70	70/70	70/70	70/70	70/70
Charpy Notched Impact +23°C	ISO 179	kJ/m ²	11/11	11/11	11/11	11/11	12/12	12/12
Melting Point	ISO 11357	°C	310/-	325/-	325/-	325/-	325/-	325/-
Heat Deflection HDT/C 8.0 MPa	ISO 75	°C	155/-	200/-	200/-	200/-	200/-	200/-
Density	ISO 1183	g/cm ³	1.47/-	1.53/-	1.53/-	1.53/-	1.64/-	1.64/-
Water Absorption, 23°C	ISO 62	%	3.5/-	3.5/-	3.5/-	3.5/-	3.0/-	3.0/-
Moisture Absorption, 23°C/50%	ISO 62	%	2.0	1.5	1.5	1.5	1.3	1.3
Shrinkage Long./Trans.	ISO 294	%	0.2/0.9	0.10/0.55	0.10/0.55	0.10/0.55	0.05/0.45	0.05/0.45
Melt Temperatures	-	%	320 to 330	330 to 340	330 to 340	330 to 340	330 to 340	330 to 340
Tool Temperature	-	°C	≥ 130	≥ 140	≥ 140	≥ 140	≥ 140	≥ 140

¹GF40, Laser transparent

Grivory HT1VA-35 HYS
Active Cooling Valve

Key properties: High hydrolysis resistance
Excellent demolding performance





■ Grivory HT6 Enhanced High Temperature

Compared to conventional PPA, Grivory HT6 has a 20 °C higher glass transition temperature with a comparable melting point. The advantage is significantly increased load-bearing capacity at high temperatures. The heat distortion temperature (HDT/C) has been increased by 50 °C to 250 °C. This is 20 °C more than with PEEK. Its extreme creep resistance makes Grivory HT6 suitable not only for components at elevated temperatures, but also wherever the highest resistance to

deformation under load is required. Despite higher performance, processing is similar to Grivory HT1, where the melting temperature is 330°C to 350°C and tool temperature starts at 160 °C. Grivory HT 6 is the first choice for highly stressed components at high and low temperatures. Compared to conventional PPA, HT6 can be used to design thin-walled components and thus reduce manufacturing and energy costs.

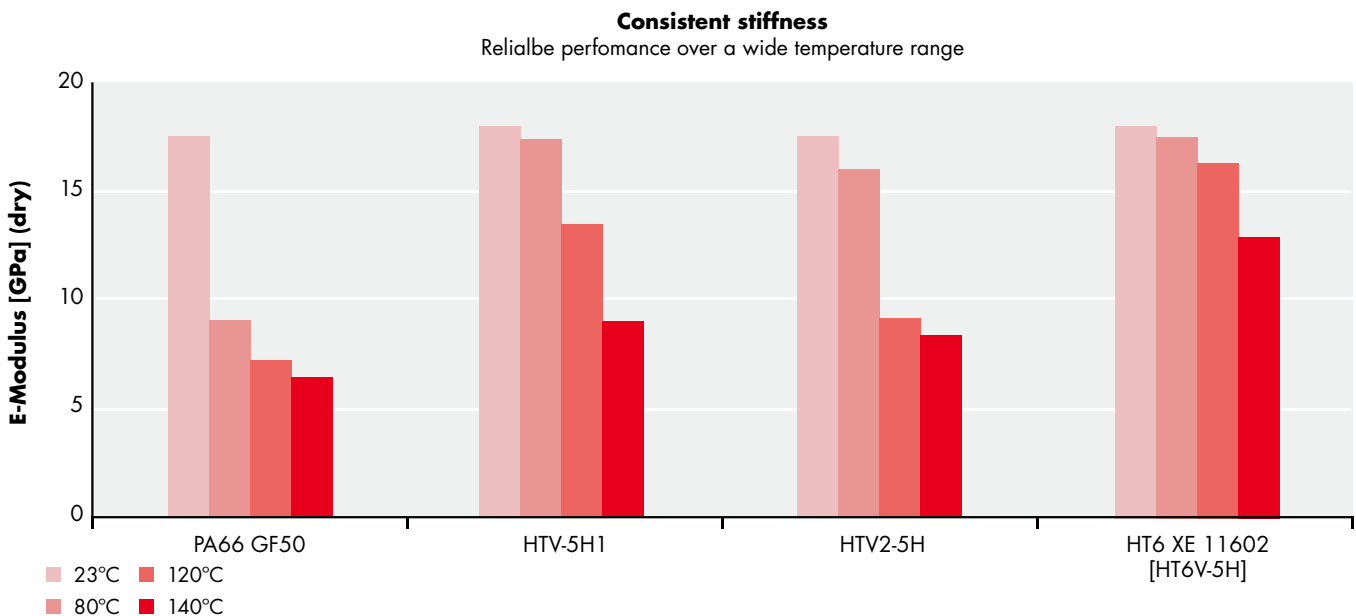
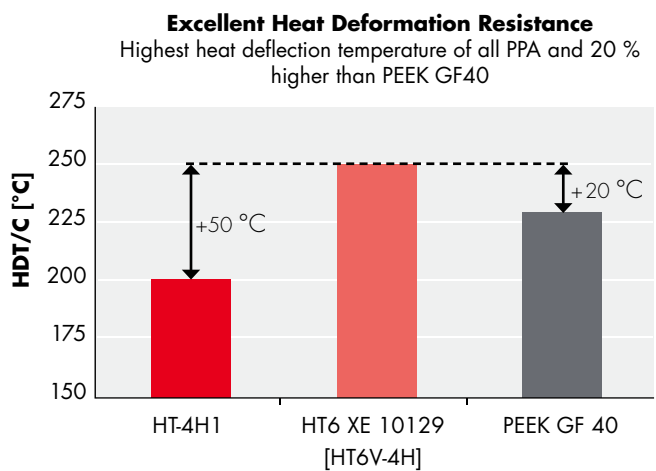
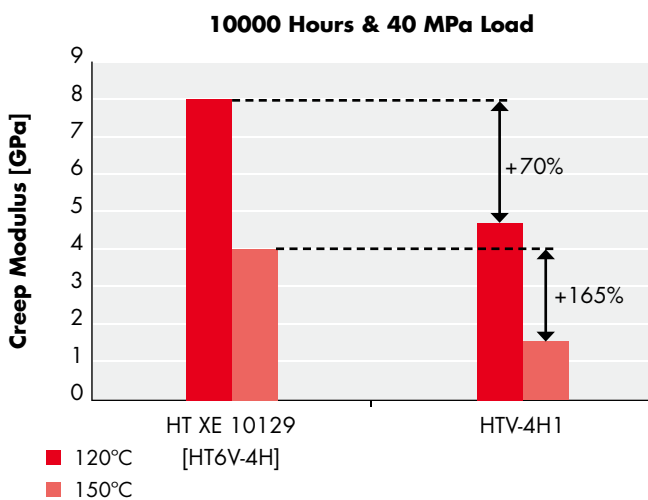

■ Cost and Weight Reduction Case Study

Cover for pressurized gearbox component

- Load case: internal pressure 20 bar/140 °C
- Fixation: 3 screws
- Critical: deflection of sealing surface (leakage)
- Max. 0,3 mm total deformation allowed

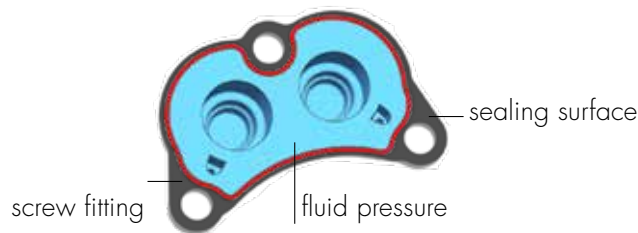
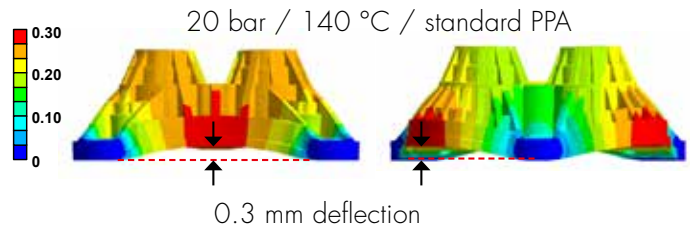

■ Redesign Adapted to Higher Material Stiffness

Original design
standard PPA

Redesign
HT XE 11602
[HT6V-5H]

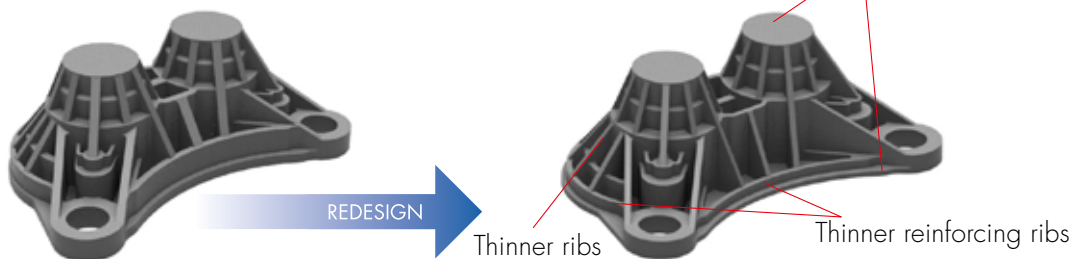

Weight: 101 g



Weight: 70 g

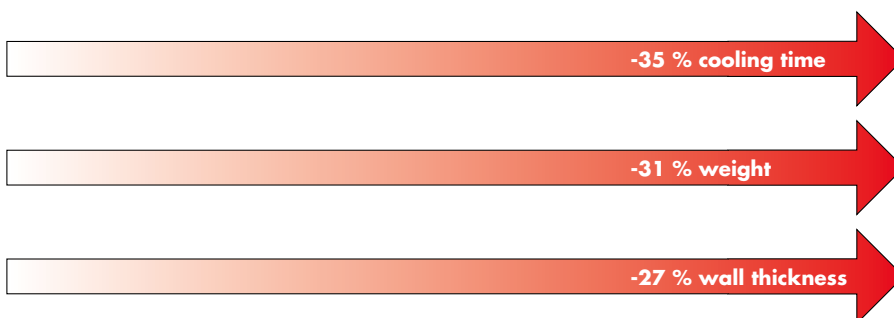



■ Grivory HT6 Core Products

Property	Standard	Unit	HT XE 10129 [HT6V-4H]	HT XE 11635 [HT6VA-4HY]	HT XE 11600 [HT6V-4X]	HT XE 11602 [HT6V-5H]	HT XE 11601 [HT6V-5X]	HT XE 11627 [HT6V-6H]
Degree of reinforcement	ISO 3451	%	40	40	40	50	50	60
E-Modulus	ISO 527	GPa	14.5/14.5	14.5/14.5	14.5/14.5	18.0/18.0	18.0/18.0	23.0/23.0
Tensile Strength at Break	ISO 527	MPa	240/240	240/240	240/240	260/260	260/260	260/260
Charpy Impact +23°C	ISO 179	kJ/m ²	60/60	60/60	60/60	70/70	70/70	70/70
Charpy Notched Impact +23°C	ISO 179	kJ/m ²	11/11	11/11	11/11	12/12	12/12	12/12
Melting Point	ISO 11357	°C	320	320	320	320	320	320
Heat Deflection HDT/C 8.0 MPa	ISO 75	°C	250/-	250/-	250/-	260/-	260/-	260/-
Density	ISO 1183	g/cm ³	1.53/-	1.53/-	1.53/-	1.65/-	1.65/-	1.78/-
Water Absorption, 23°C	ISO 62	%	3.5	3.5	3.5	3	3	3
Moisture Absorption, 23°C/50%	ISO 294	%	1.5	1.5	1.5	1.2	1.2	1.2
Mold Shrinkage Long./Trans.	ISO 294	%	0.15/0.75	0.15/0.75	0.15/0.75	0.15/0.6	0.15/0.6	0.15/0.55
Melt Temperatures	–	%	330–340	330–340	330–340	330–340	330–340	330–340
Tool Temperature	–	°C	≥ 160	≥ 160	≥ 160	≥ 160	≥ 160	≥ 160

Values represent [dry/conditioned] states

Grivory HT

■ Basic Product Assortment

■ HT1

Grades	Reinforcement	Characteristics
HTV-3H1 HTV-4H1 HTV-5H1 HTV-6H1	30% glass fiber 40% glass fiber 50% glass fiber 60% glass fiber	Exhibiting well-balanced mechanical, chemical, and thermal performance. Usage for functional parts in contact with chemicals at high applications temperatures.
HTV-4X1 HTV-5X1 HTV-6X1	40% glass fiber 50% glass fiber 60% glass fiber	Electro-compatible stabilisation. For application requiring resistance to high electrical voltage, in humid and hot environments.
HT XE 12301 HT XE 12303 HT XE 12304	40% glass fiber 50% glass fiber 60% glass fiber	For higher CTI values, electro-compatible stabilization.

■ HT3: PPA partially based on renewable raw material

Grades	Reinforcement	Characteristics
HT3Z HT3Z LF	0	Low friction, exhibiting improved tribological properties.
XE 4063 BLACK 9238	GF30	General purpose, high dimensional stability.
XE 4095	GF50	High flow
XE 4101 BLACK 9225	GF40	Drinking water and food approved. ¹⁾
XE 4027	GF30	Flame retardant UL 94 V0

¹⁾ NSF 61 82°C; ACS 23°C; KTW 23°C; W270/
DIN EN 16421 Food contact: EU 10/2011;
USA FDA Food Contact Notification 1170;
JP Notification No. 196 / 2020

■ HT2

Grades	Reinforcement	Characteristics
HT2V-3H HT2V-4H HT2V-5H HT2V-6H	30% glass fiber 40% glass fiber 50% glass fiber 60% glass fiber	General purpose, with well-balanced mechanical and thermal properties. Suitable for water-cooled moulds.
HT2V-3X V0 HT2V-4X V0 HT2V-5X V0	30% glass fiber 40% glass fiber 50% glass fiber	Flame retardant, halogen-free, UL 94 V0.
HT2V-3H LF	30% glass fiber	Low friction, exhibiting improved tribological properties.
HT2C-3X	30% carbon fiber	Electrically conductive, unbeatable strength/density ratio.
HT2C-3X LF	30% glass fiber	Electrically conductive, unbeatable strength/density ratio, low friction, exhibiting improved tribological properties.
HT XE 16125	50% long glass fibre	High stiffness, high creep resistance.



■ **EMS-GRIVORY** **Service and Support**

EMS-GRIVORY is a specialist in polyamide synthesis and the processing of polyamide materials. Our services focus on the success of customer applications with our specialty products and range from manufacturing and material supply to full technical support.

Quality System Certification

IATF 16949:2016

All manufacturing sites

Laboratory Accreditation

ISO/IEC 17025:2017

Sumter South Carolina Site

Design Concept

Design Proposals (Variants)

Part Cost Calculations

Material Selection

Comparative evaluation

Design Evaluation

Design recommendations

Moldflow and FEA

Prototypes

Prototype production

Die cast tool modification

Application Related Tests

Test method development

Characterization and Analysis

Sampling and start of production

Processing and tool optimization

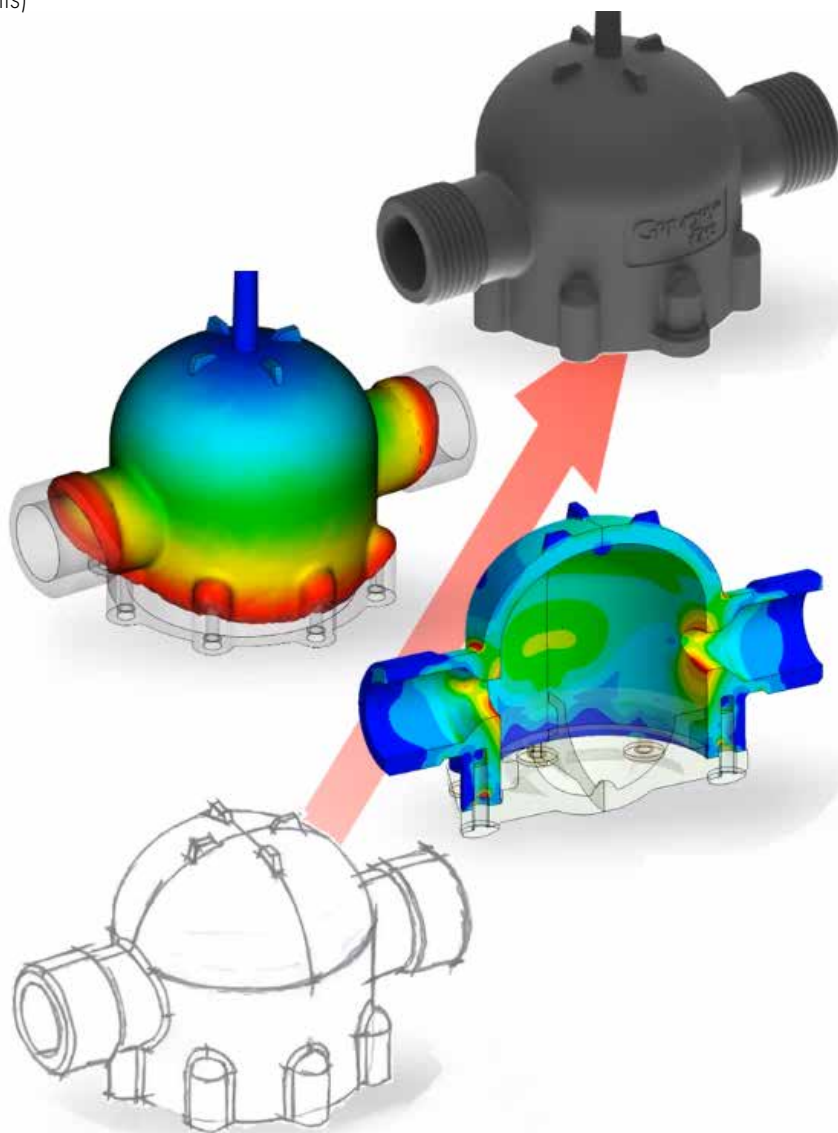

Grivory HT



You receive comprehensive technical support from our Application Development Center.



Temperature module and test chamber in material testing.



EMS-GRIVORY worldwide

www.emsgrivory.com

EMS-GRIVORY – The leading manufacturer of high-performance polyamides

EMS-GRIVORY is the leading manufacturer of high-performance polyamides and the supplier with the widest range of polyamide materials. Our products are well-known throughout the world under the trademarks Grilamid, Grivory and Grilon.

We offer our customers a comprehensive package of high-capacity and high-quality products along with segment-specific advisory competence in distribution and application development. We maintain our market leadership through continual product and application development in all segments.

EMS-GRIVORY Europa

Switzerland

EMS-CHEMIE AG
Business Unit EMS-GRIVORY Europe
Via Innovativa 1
7013 Domat/Ems
Switzerland
Phone +41 81 632 78 88
welcome@emsgrivory.com

Germany

EMS-CHEMIE (Deutschland) Vertriebs GmbH
Warthweg 14
64823 Gross-Umstadt
Germany
Phone +49 6078 783 0
Fax +49 6078 783 416
welcome@de.emsgrivory.com

France

EMS-CHEMIE (France) S.A.
Vélizy Espace, Immeuble Le Blériot
13 avenue Morane Saulnier
78140 Vélizy-Villacoublay
France
Phone +33 1 41 10 06 10
Fax +33 1 48 25 56 07
welcome@fr.emsgrivory.com

Great Britain

EMS-CHEMIE (UK) LTD
Barn 4C
Dunston Business Village
Dunston
Stafford
ST18 9AB
Great Britain
Phone +44 1785 283 734
Fax +44 1785 283 722
welcome@uk.emsgrivory.com

Italy

EMS-CHEMIE (Italia) S.r.l.
Via Carloni 56
22100 Como (CO)
Italy
Phone +39 011 0604522
Fax +39 011 0604522
welcome@it.emsgrivory.com

EMS-GRIVORY Asia

China

EMS-CHEMIE (China) Ltd.
227 Songbei Road
Suzhou Industrial Park
Suzhou City 215126
Jiangsu Province
P. R. China
Phone +86 512 8666 8180
Fax +86 512 8666 8210
welcome@cn.emsgrivory.com

EMS-CHEMIE (Suzhou) Ltd.

227 Songbei Road
Suzhou Industrial Park
Suzhou City 215126
Jiangsu Province
P. R. China
Phone +86 512 8666 8181
Fax +86 512 8666 8183
welcome@cn.emsgrivory.com

Taiwan

EMS-CHEMIE (Taiwan) Ltd.
36, Kwang Fu South Road
Hsin Chu Industrial Park
Fu Kou Hsiang
Hsin Chu Hsien 30351
Taiwan, R. O. C.
Phone +886 3 598 5335
Fax +886 3 598 5345
welcome@tw.emsgrivory.com

Korea

EMS-CHEMIE (Korea) Ltd.
#817 Doosan Venturedigim,
415 Heungan Daero,
Dongan-gu, Anyang-si,
Gyeonggi-do, 14059
Republic of Korea
Phone +82 31 478 3159
Fax +82 31 478 3157
welcome@kr.emsgrivory.com

Japan

EMS-CHEMIE (Japan) Ltd.
EMS Building
2-11-20 Higashi-koujiya
Ota-ku, Tokyo 144-0033
Japan
Phone +81 3 5735 0611
Fax +81 3 5735 0614
welcome@jp.emsgrivory.com

EMS-GRIVORY America

United States of America

EMS-CHEMIE (North America) Inc.
2060 Corporate Way
P.O. Box 1717
Sumter, SC 29151
USA
Phone +1 803 481 91 73
Fax +1 803 481 61 21
welcome@us.emsgrivory.com

EMS-GRIVORY,
a business unit of the EMS Group

EMS
EMS-GRIVORY